

Bible for Children
presents

SAMUEL, GOD'S
BOY - SERVANT



Written by: Edward Hughes
Illustrated by: Janie Forest
Adapted by: Lyn Doerksen
Produced by: Bible for Children
www.M1914.org

BFC
PO Box 3
Winnipeg, MB R3C 2G1
Canada

©2007 Bible for Children, Inc.

License: You have the right to copy or print this story,
as long as you do not sell it.



Hannah was a good woman, married to Elkanah, a good man. They both worshipped God and showed kindness to others. But something was missing

from Hannah's life. She wanted to have a baby. Oh, how she wanted a baby! She waited and prayed and hoped and waited some more. No baby came!

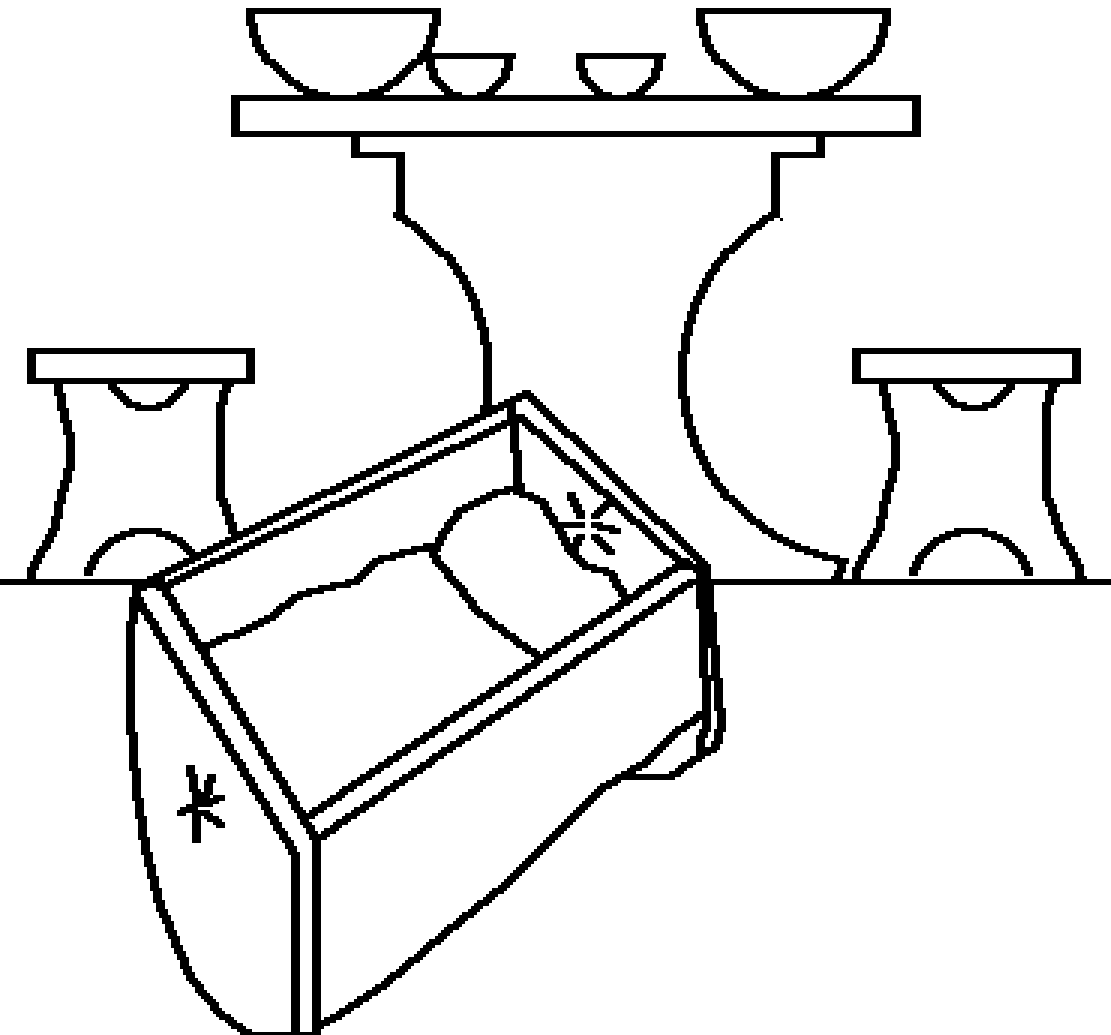

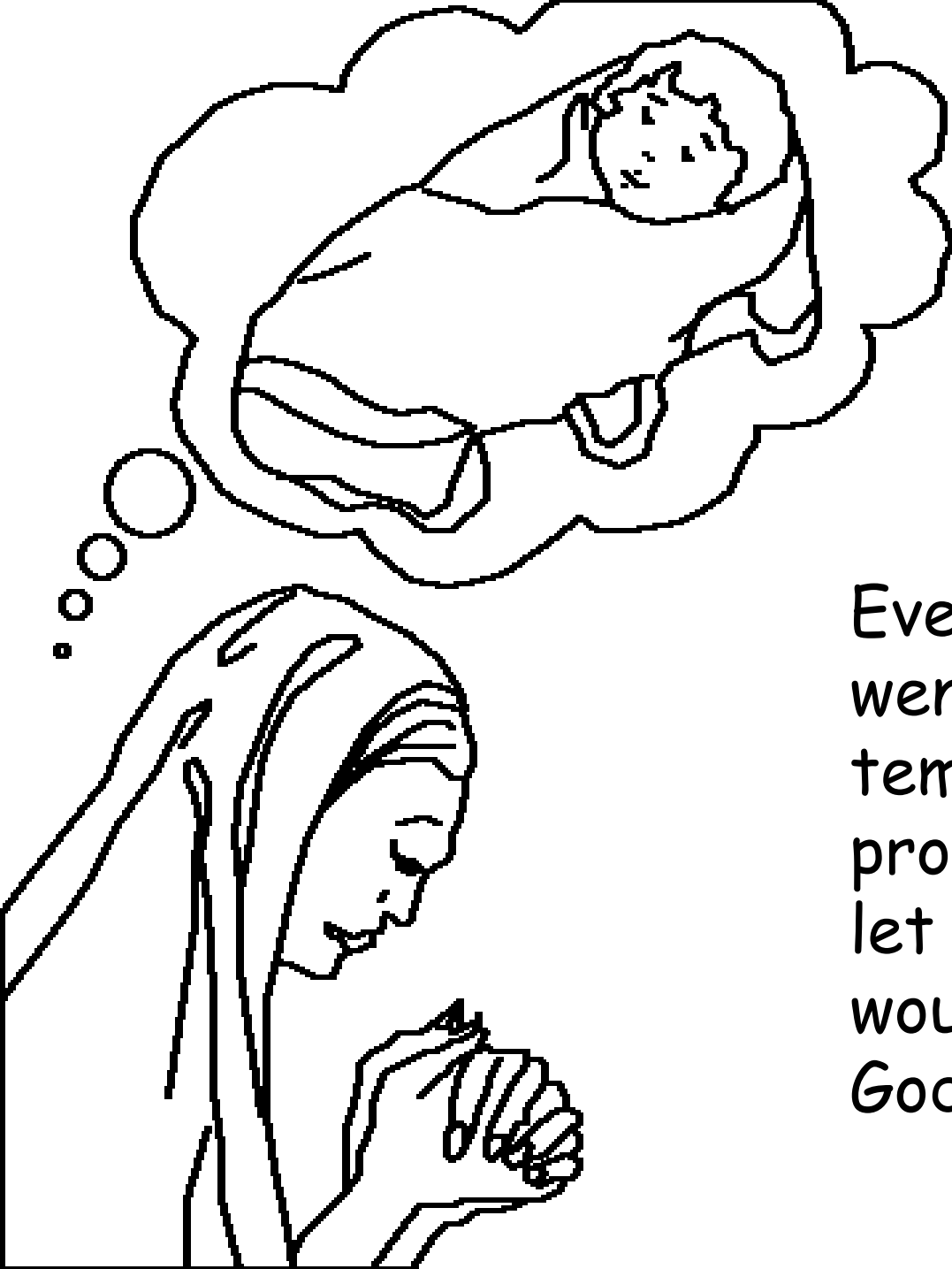

Every year, Hannah went to worship at God's temple. One year she promised God that if He let her have a son, she would give the boy to be God's servant forever.





Old Eli the priest
saw Hannah praying.
He thought Hannah
was drunk with wine
because her lips
moved but no
sound came.
Eli scolded
Hannah!

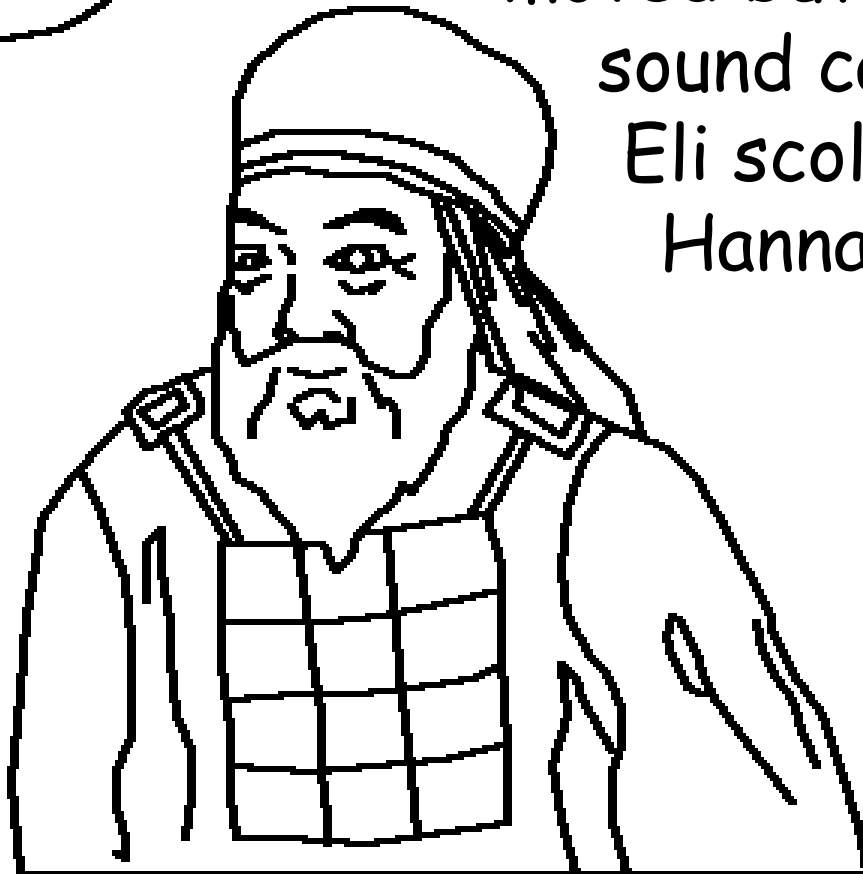



But Hannah told Eli about her prayer for a child and her promise to God. "Go in peace," Eli answered. "And the God of Israel grant your petition which you have asked of Him." Eli's words gave Hannah hope.



Soon great joy filled Hannah's heart. "The Lord remembered her" and answered her prayer. She and Elkanah had a little boy who was named Samuel (which means "Heard by God"). But would Hannah remember the Lord and her promise to Him?

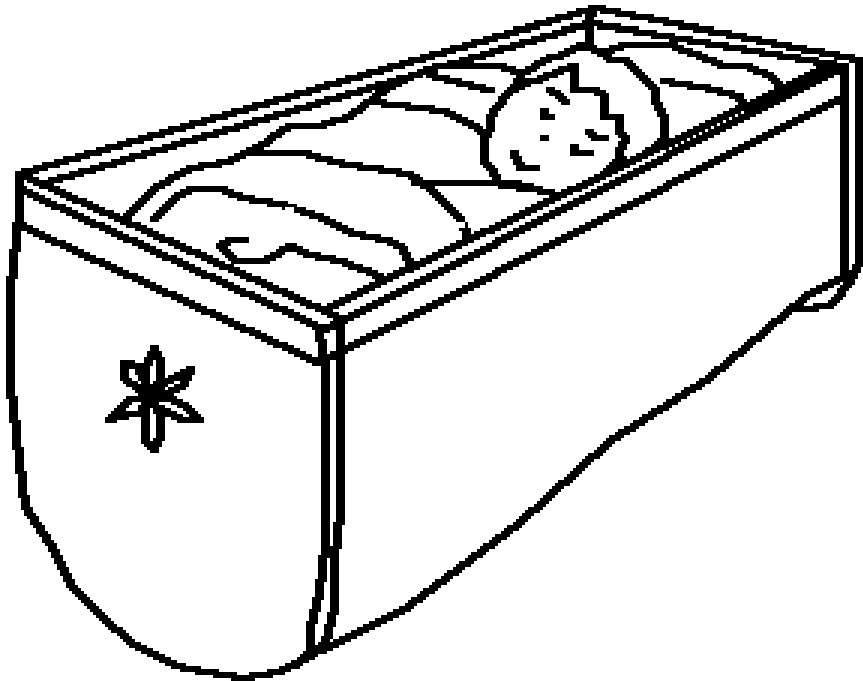



Hannah stopped going to the temple each year. Oh, dear! Had she broken her promise to God? No, Hannah was waiting until Samuel was old enough to live at the temple and help Eli in God's service. Then she brought him to the temple.





God honored Hannah's great faithfulness. After Samuel, God gave her three more sons and two daughters. Every year, Hannah went to the temple to worship God - and to bring a new robe she made for Samuel.



Samuel was not Eli's only helper. Eli's sons, Hophni and Phinehas, also worked there. But they dishonored God by doing wicked things, and would not change

even when their father Eli begged them. Eli should have fired them from working in the temple. But he didn't.

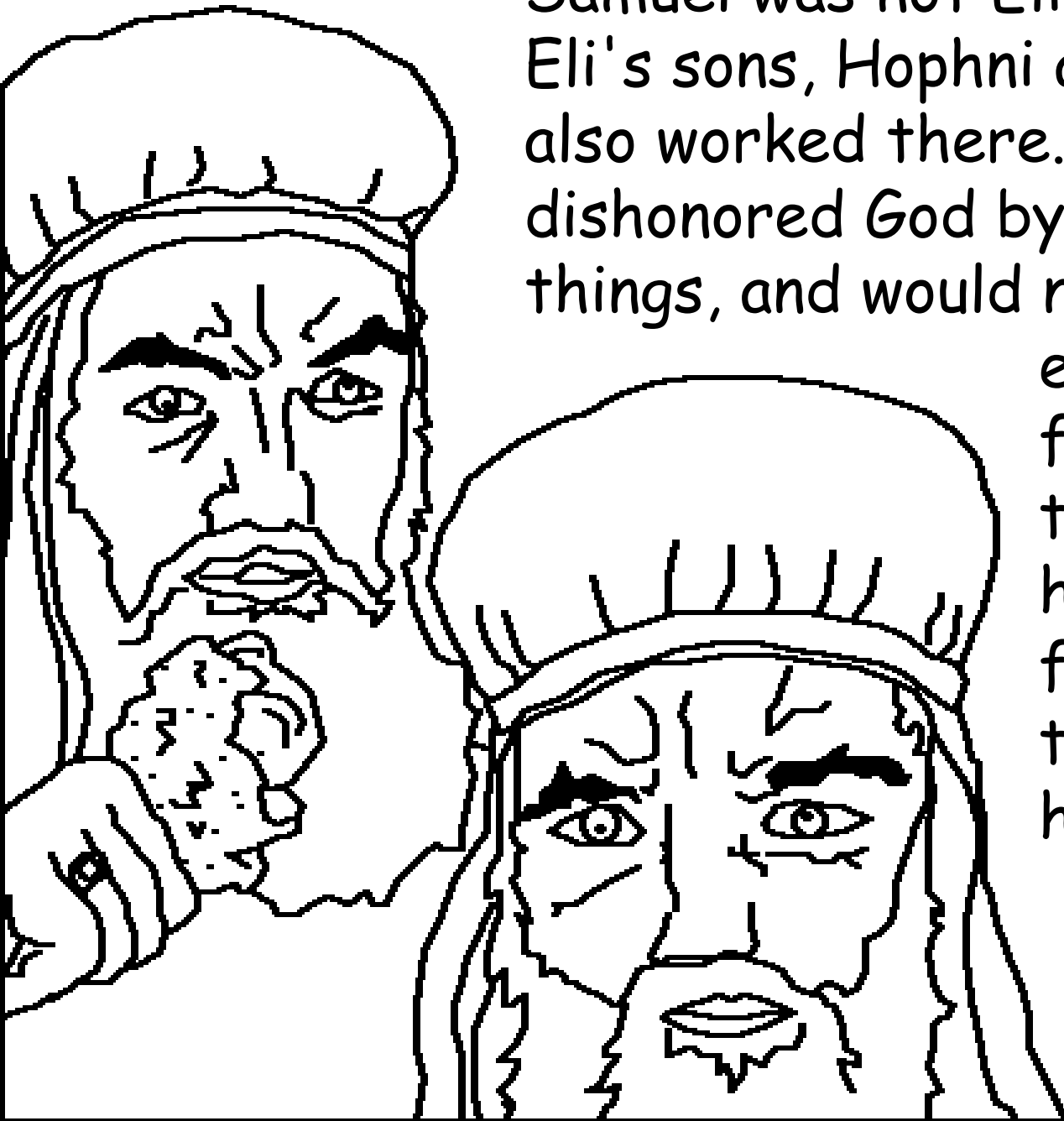

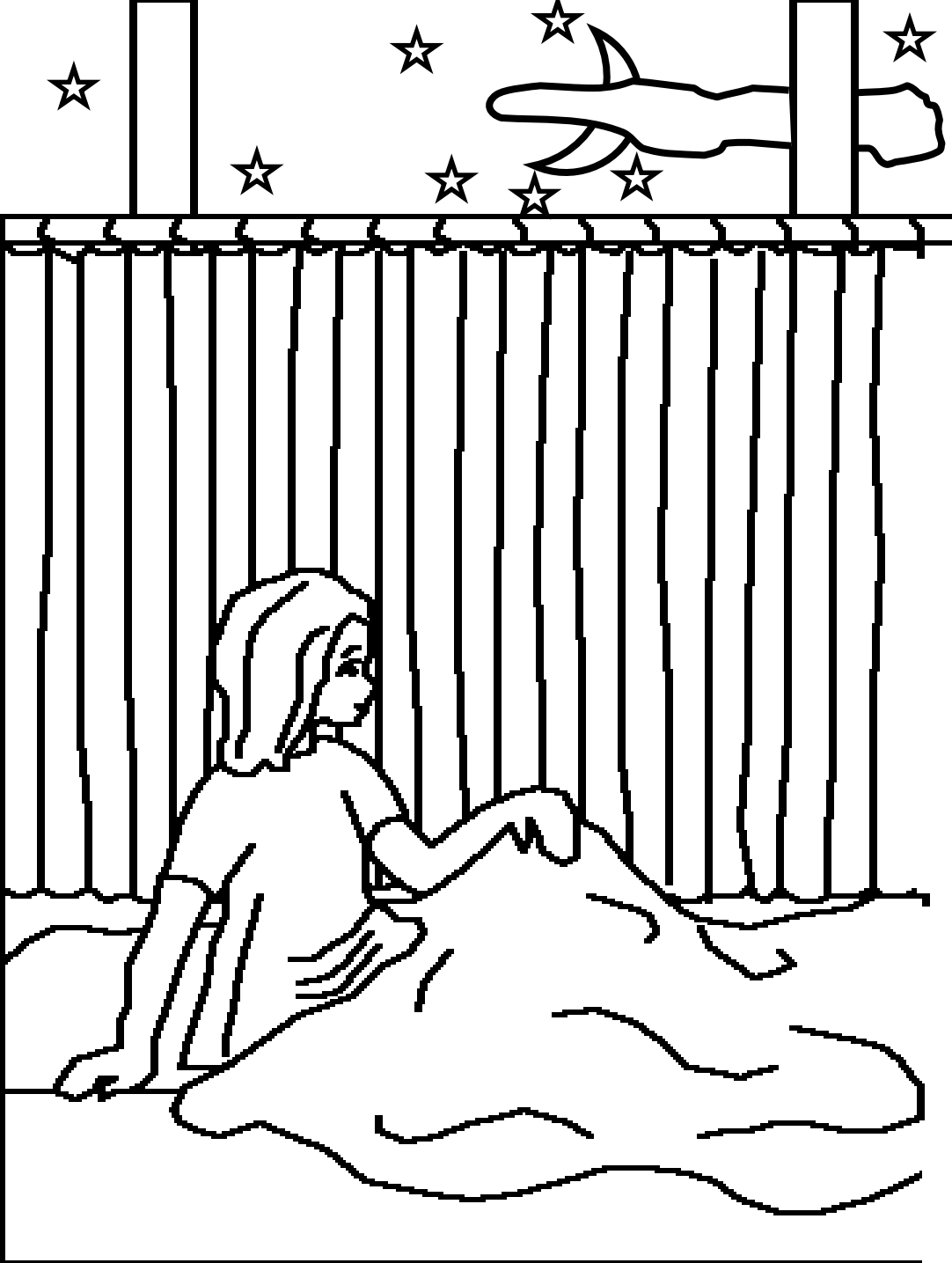

One night, Samuel heard a voice call him. The boy thought it was Eli calling. "Here I am," he said. "I did not call," Eli replied. This happened three times. Then Eli knew God wanted to speak to Samuel.



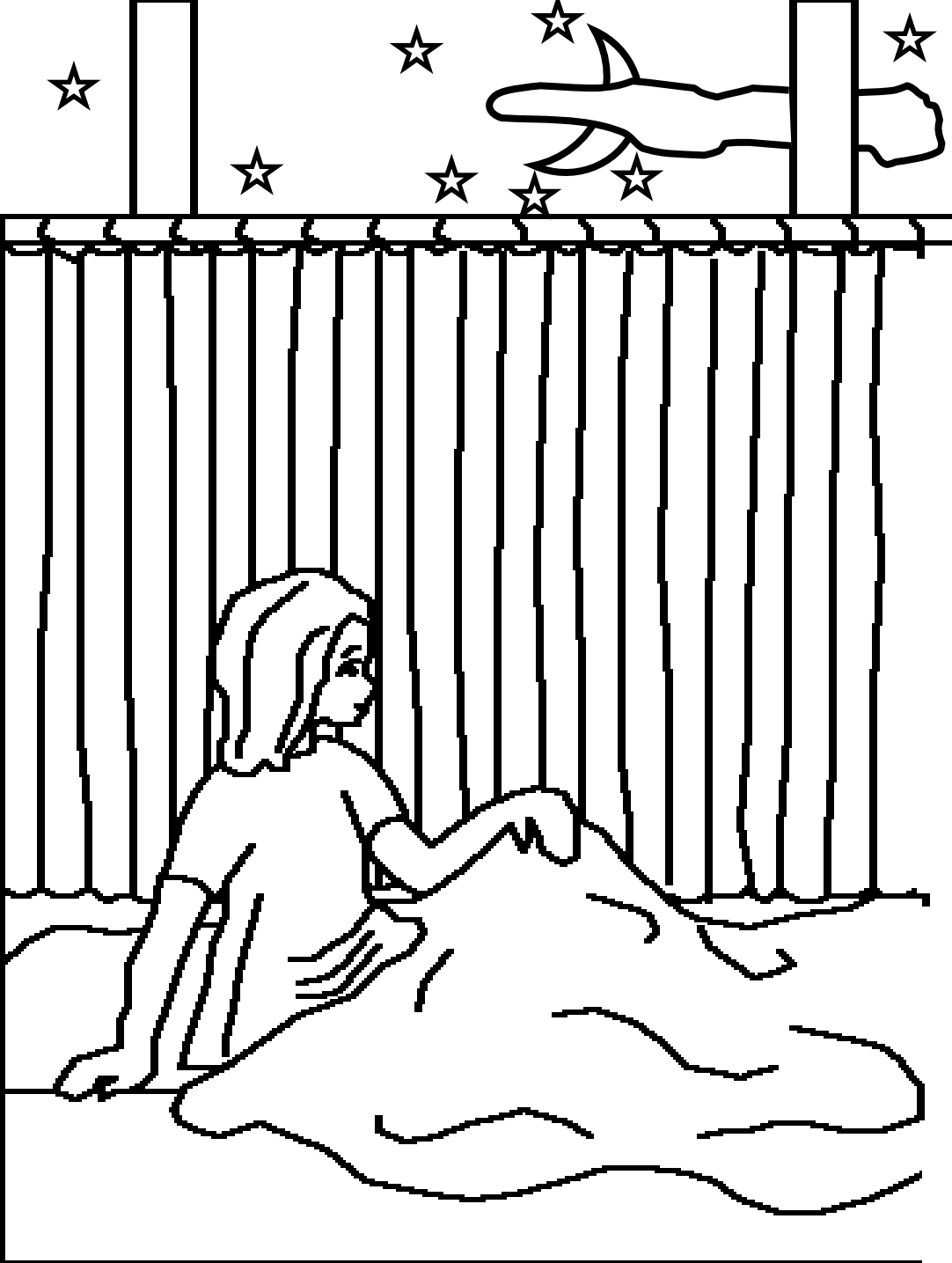

Eli told Samuel,
"If He calls you,
you must say,
'Speak LORD,
for Your servant
hears.'" And God
did call again, and
gave Samuel a
very important
message.



In the morning Eli called Samuel. "What is the thing that the Lord has said to you?" he asked. Young Samuel told him everything. It was a terrible message - God was going to destroy Eli's whole family because Hophni and Phinehas were so wicked.



God's warning came true. During a war with the Philistines, Eli's two evil sons led the Ark of God before Israel's army. The enemy captured the Ark and killed Hophni and Phinehas along with many Israelites. When Eli heard this, he fell off his seat, broke his neck, and died the same day.

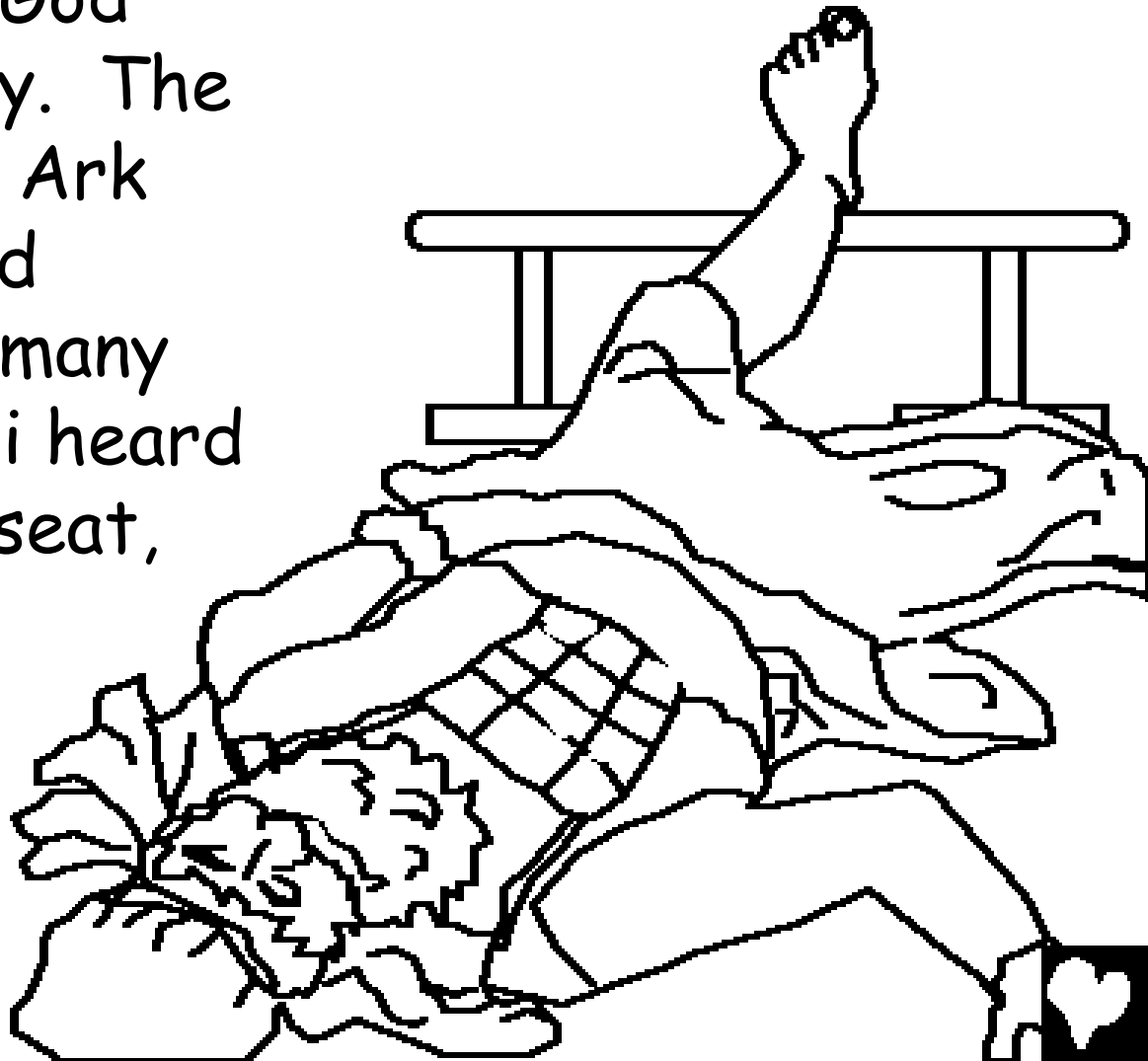

The Ark of God brought trouble to the Philistines. They put it in the temple of Dagon, their false god. In the morning, the idol Dagon had fallen on its face. The Philistines lifted Dagon up - but next morning he was down again. This time Dagon was broken in pieces.

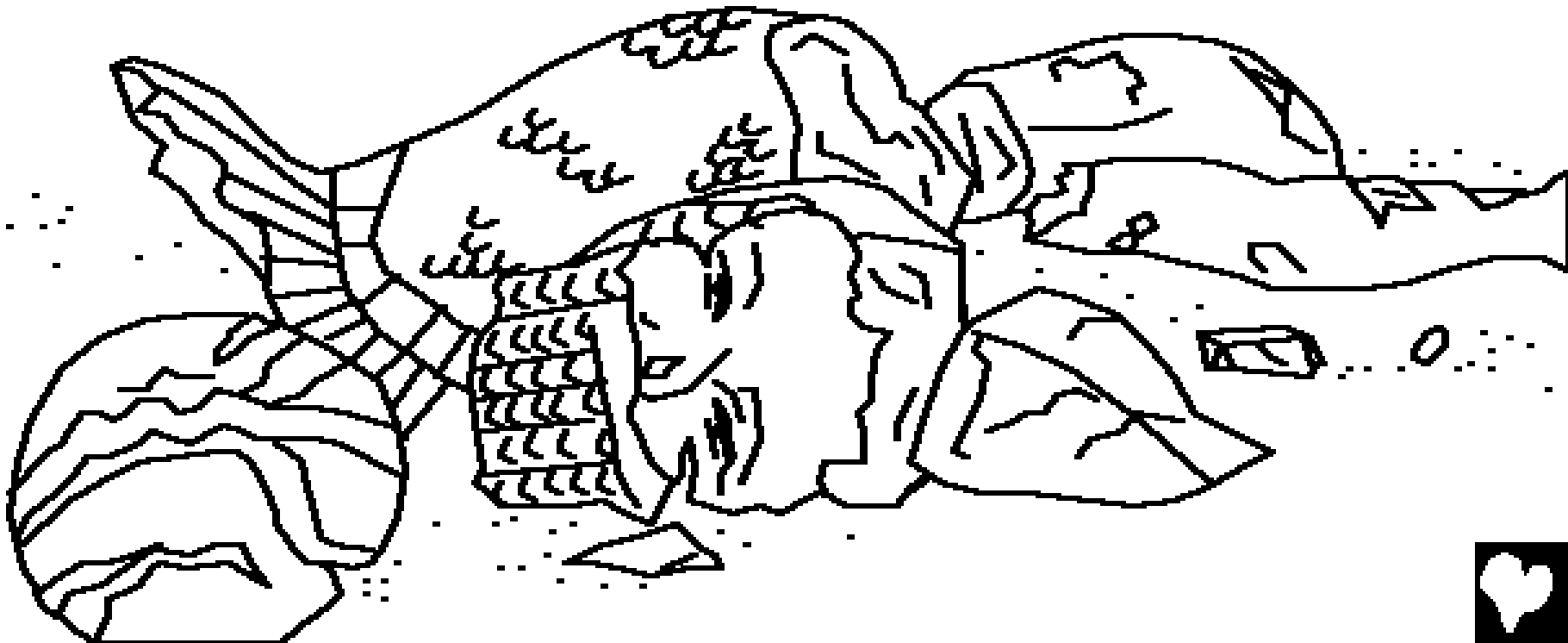

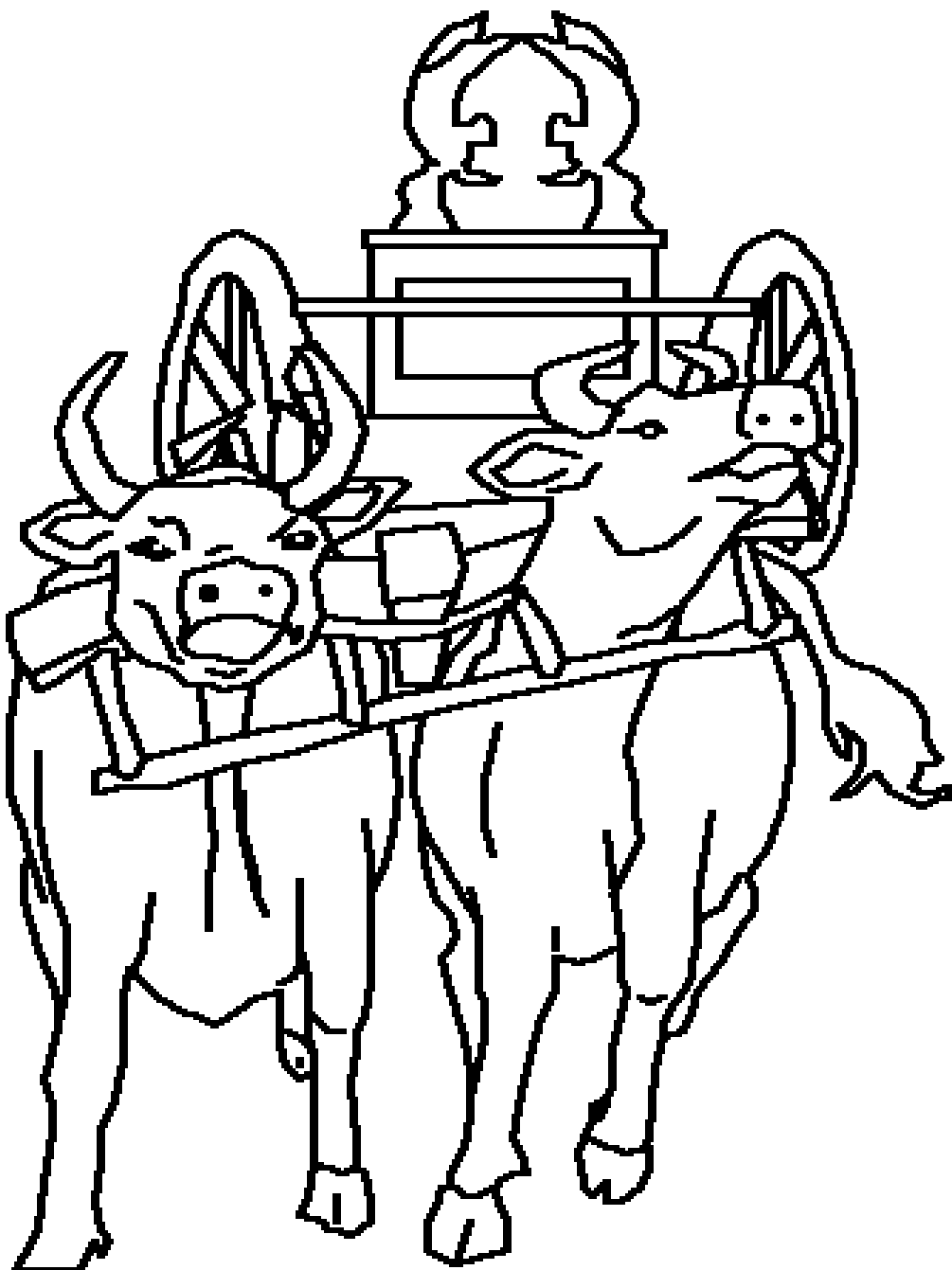

Sickness and death spread among the Philistines. To see if God was punishing them, the Philistines had two cows pull a cart with the Ark aboard. But they kept the cows' calves. "If the cows go up to Israel, and leave their calves, we will know God has done it," they said. And the cows went up!



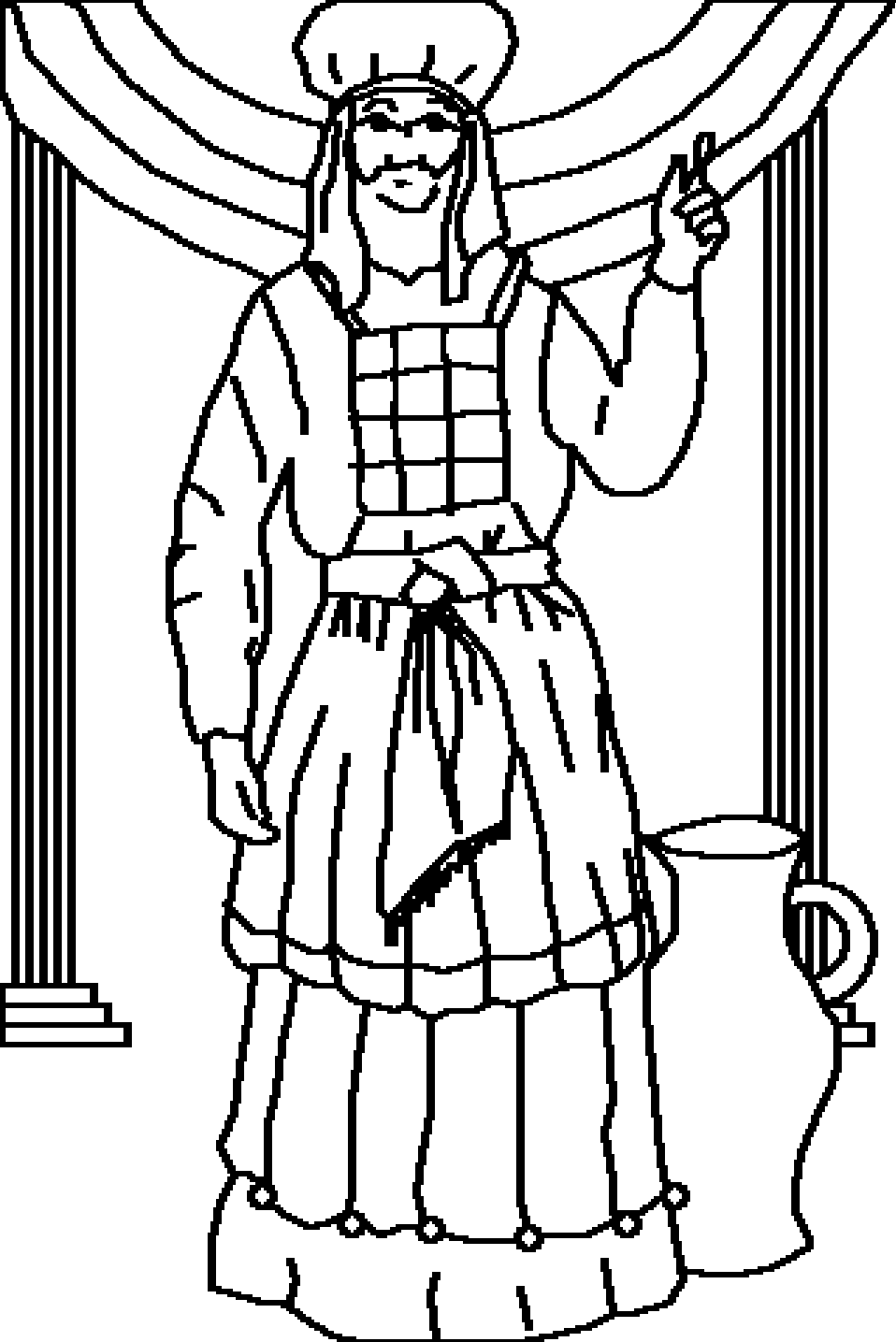

Then Samuel, who was now a grown man, spoke to all the people of Israel. "If you return to the Lord with all your heart . . . He will deliver you from the hand of the Philistines." The people obeyed God's faithful prophet. And the hand of the Lord was against the Philistines all the days of Samuel.



Samuel, God's Boy-Servant

A story from God's Word, the Bible,

is found in

1 Samuel 1-7

"The entrance of Your Word gives light."

Psalm 119:130



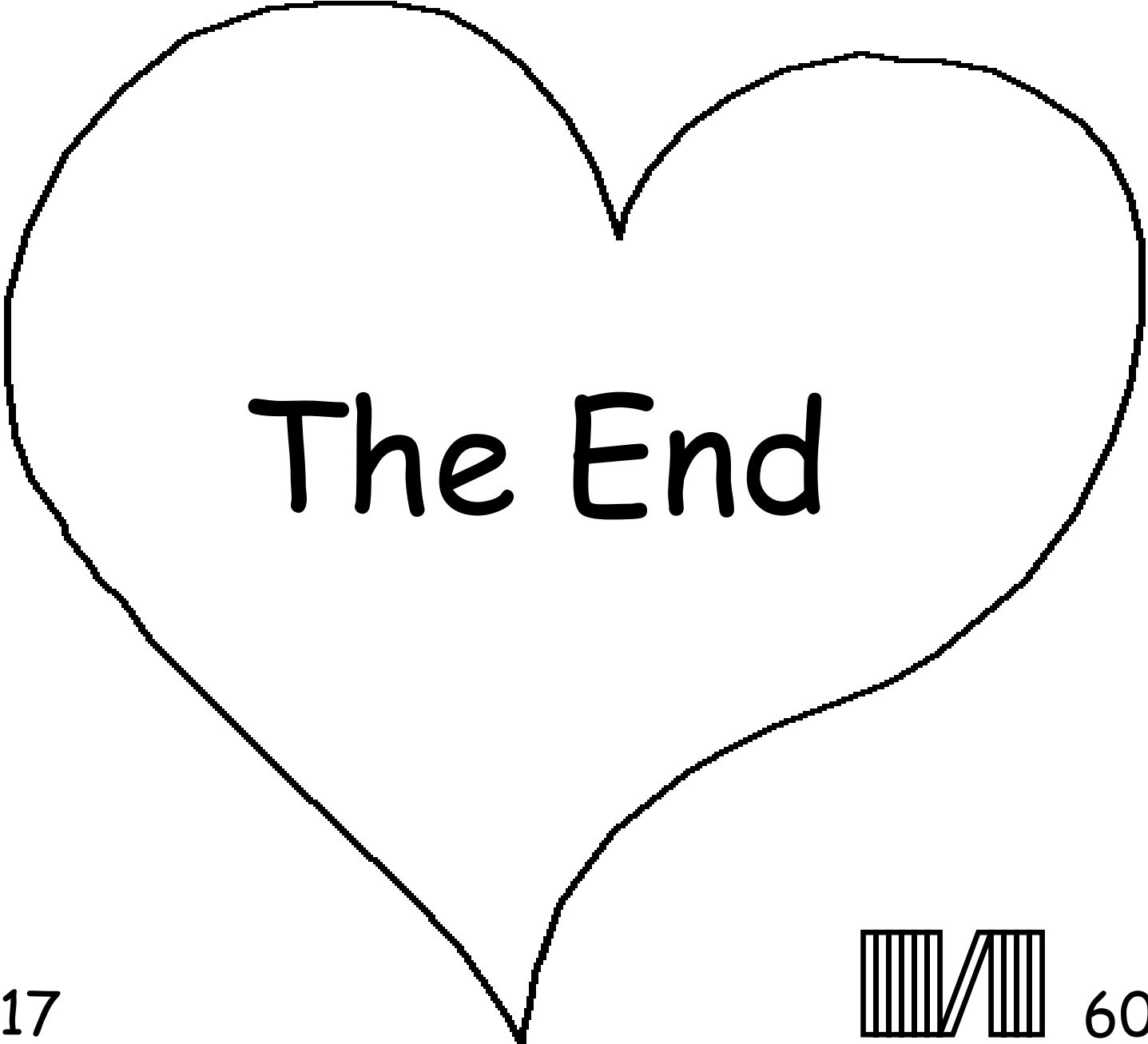

The End



This Bible story tells us about our wonderful God who made us and who wants us to know Him.

God knows we have done bad things, which He calls sin.

The punishment for sin is death, but God loves us so much He sent His Son, Jesus, to die on a Cross and be punished for our sins. Then Jesus came back to life and went home to Heaven! If you believe in Jesus and ask Him to forgive your sins, He will do it! He will come and live in you now, and you will live with Him forever.

If you want to turn from your sins, say this to God:

Dear God, I believe that Jesus died for me and now lives again. Please come into my life and forgive my sins, so that I can have new life now, and one day go to be with You forever. Help me to live for You as Your child. Amen.

Read the Bible and talk with God every day! John 3:16

